

Lijnverlichting

LED Flexibele Strip Diamond Serie (IP68)

De Flexibele LED Strip Diamond Serie is een laagspanning Super Bright LED licht in een flexibele dunne PCB strip die verkrijgbaar is in een zeer robuuste IP68 uitvoering. Alle strips zijn ontworpen voor professionele verlichting. Het wordt toegepast in de architectuur, belettering verlichting, koofverlichting en vele andere applicatie gebieden.









De Flexibele LED strips zijn verkrijgbaar in de kleuren rood, geel, blauw, groen, paars, wit, warm wit en RGB. De strip is leverbaar per meter met een maximale lengte van 30 meter.

Omhuld door een geëxtrudeerde PVC afscherming, is de strip bestand tegen ultraviolette en infrarode straling.

De strip is vlak en kan eenvoudig gemonteerd worden op bijna elke vlakke ondergrond. De strip is van klein formaat en maakt gebruik van een lage spanning. Dit maakt het product ideaal toepasbaar in een veelvoud van applicaties.

De Flexibele LED strip kan op maat geknipt worden. Ook kan de strip weer verenigd worden door middel van connectoren of met connectoren met een snoer er tussen. De Flexibele LED Strip is verkrijgbaar in een 24 volts uitvoering.



IP68 LED strip	Voltage	Type LED	LEDs/m	✂️ (cm)	Afmetingen (LxBxH) (mm)	Vermogen W/m	Lm/m	Art. nr.	Kleur
	24Vdc	3528	42	16,6	1000x12x6	2,9	26	46280000	
							23	46280001	
							24	46280002	
							101	46280003	
						3,6	294	46280004	
						235	46280005		
		2,9	4	46280006					
5050	28	25	1000x17x12	5,8	112	46280007			

* De flexibele strip diamond serie is leverbaar per meter met een maximale lengte van 30 meter



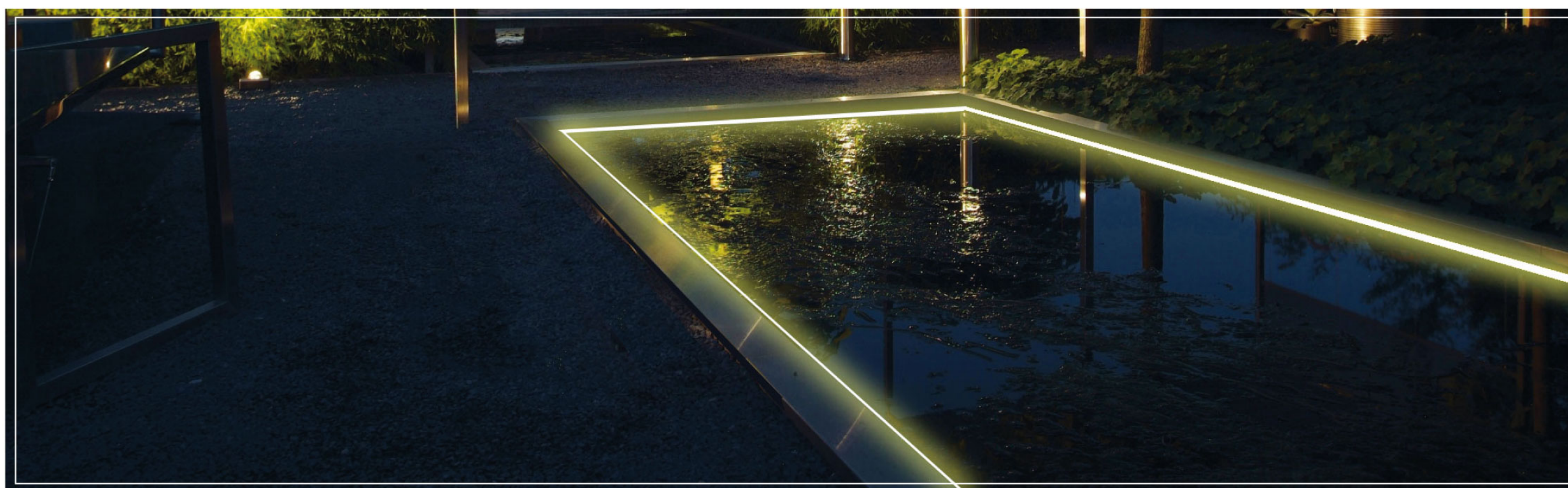

Accessoires

	Art. nr.	Omschrijving
	46280110	Montageclip t.b.v. single colour diamond strip
	46280111	Montageclip t.b.v. RGB diamond strip
	46280112	Connector, doorverbinding single colour
	46280113	Connector, doorverbinding RGB
	46280114	Connector, doorverbinding single colour, met snoer
	46280115	Connector, doorverbinding RGB, met snoer
	46280116	Aansluitsnoer 1m, single colour
	46280117	Aansluitsnoer 1m, RGB
	46280118	Aansluitsnoer 5m, single colour
	46280119	Aansluitsnoer 5m, RGB
	46280120	Eindkap single color
	46280121	Eindkap RGB
	46280122	Siliconenlijm
	46280124	Versterker IP65
	46280123	RGB controller IP65 * beschikt over 22 verschillende modussen

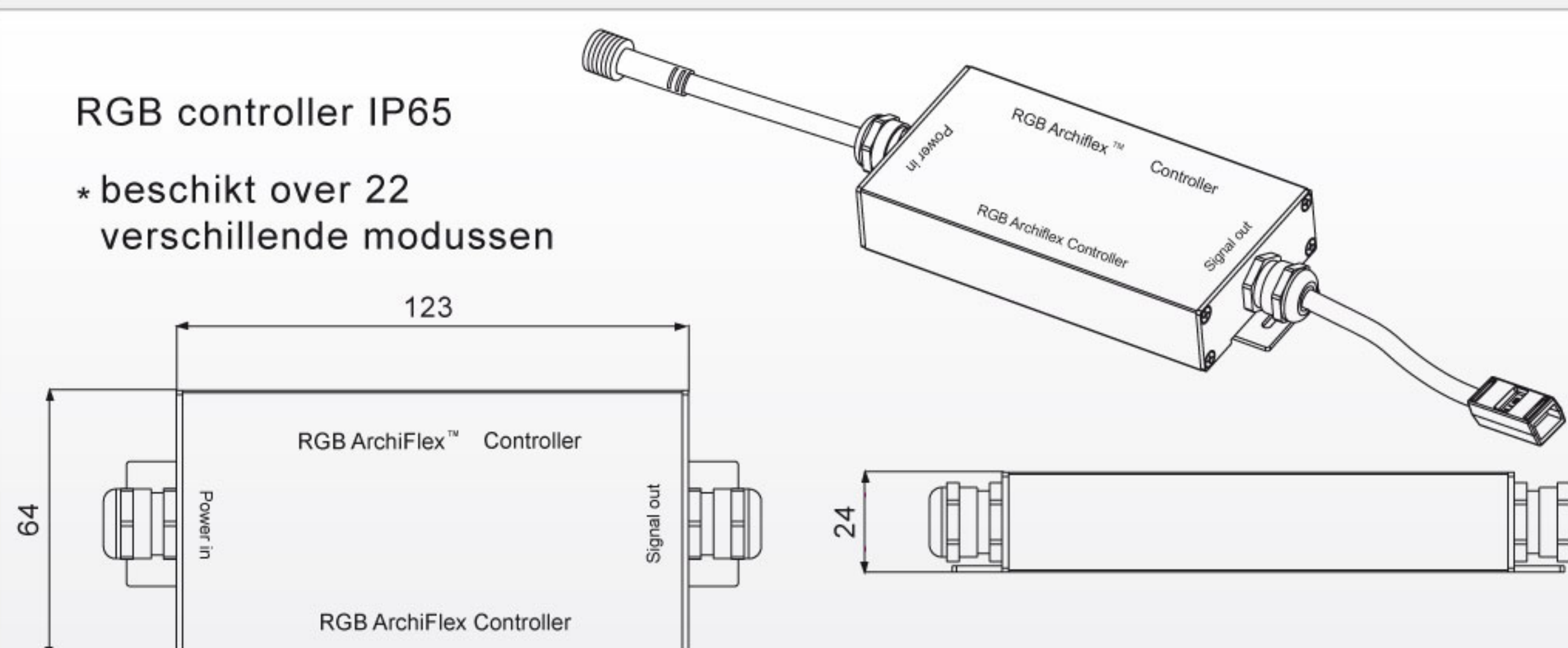

Zie pagina 17 voor voedingen en overige controllers